

BABYSTART TRAVELCOT

Assembly Instructions - Please keep for future reference | 910/4079

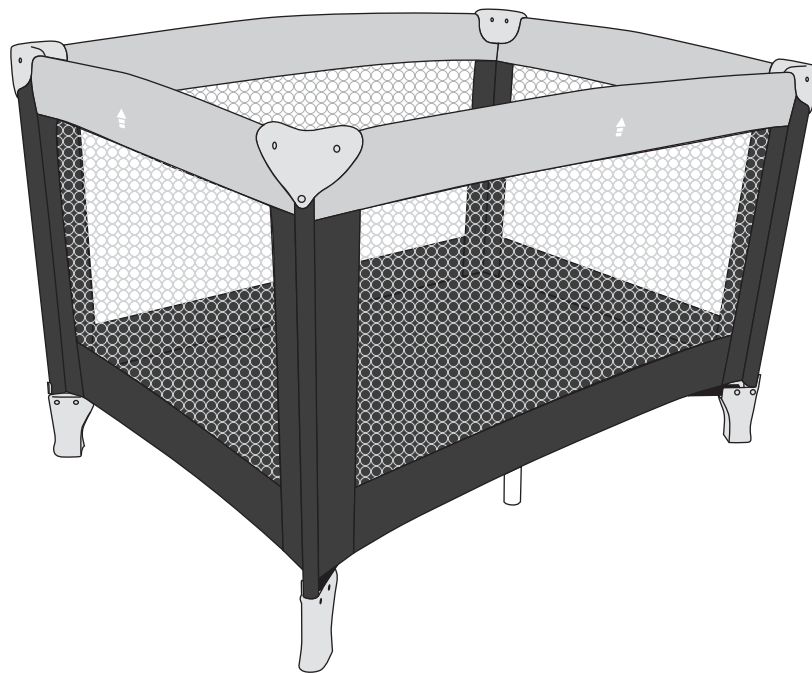

Dimensions

Width - 74cm

Length - 100cm

Height - 78cm

Suitable from birth to 24 months, up to 15kgs

IMPORTANT!
RETAIN FOR FUTURE REFERENCE: READ CAREFULLY

If you need help or have damaged or missing parts, call the **Customer Helpline: 03456 400 800**



Safety and Care Advice

Important – Please read these instructions fully before starting assembly

- **WARNING** Be aware of the risk of open fire and other sources of heat, such as electric bar fires, gas fires etc in the near vicinity of the cot.
- **WARNING** Do not use the cot if any part is broken, torn or missing and use only spare parts approved by the manufacturer.
- **WARNING** Do not leave anything in the cot, such as toys, or place the cot close to another product, which could provide a foothold or present a danger of suffocation or strangulation, e.g. strings, blind/curtain cords etc.
- **WARNING** Do not use more than one mattress in the cot.
Recommendatory mattress size is 940*680mm.
- **WARNING** Do not use your travel cot without the mattress.
- **WARNING** The depth of the mattress should not reduce the side height above it to less than 500mm
- **WARNING** Keep your travel cot away from trailing cords or flexes.
- **WARNING** Failure to extend the top rails and lock them securely creates a safety risk. ALWAYS check that the rails are fully engaged before use.
- **WARNING** To prevent injury from falls, if the child can stand unaided or is able to climb out of the cot, the cot shall no longer be used for that child.
- **WARNING** Do not use any other mattress which are not approved by the manufacturer.
- **WARNING** Do not allow young children to play unsupervised in the vicinity of the travel cot.
- **WARNING** Do not use the bassinet when the child can sit or kneel or pull itself up.
- **WARNING** Never leave your child unattended in the changing station.
- It complies with [EN716-1&-2:2008+A1: 2013](#)

1.Parts List

If you have damaged or missing components,
call the **Customer Helpline: 03456 400 800**

Please check you have all the parts listed below

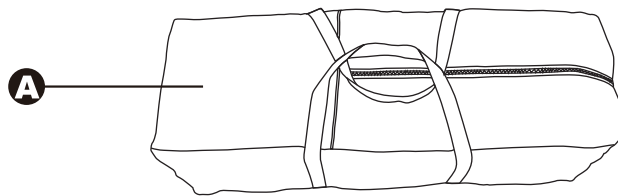

Carry bag

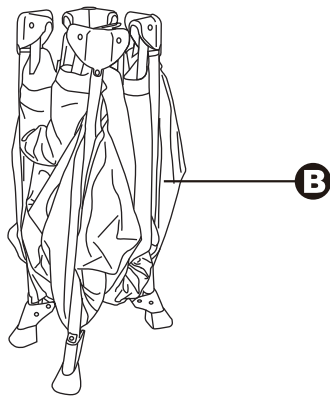

Frame

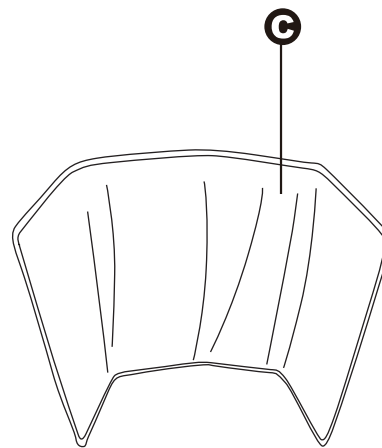

Mattress

2. Opening for use

Step1

Unzip the travel bag and remove the frame and mattress. Place the cot in the vertical position and open the touch fasteners to remove the mattress.

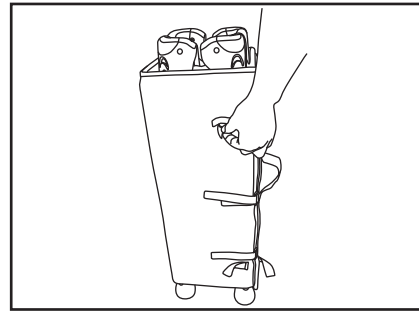

Step2

With the feet on the floor pull the feet apart so that they are approximately 60cm/24" apart. Lift the short sides of the cot upwards until they lock into position.

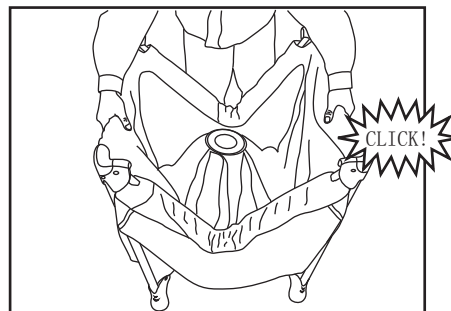

Step3

Now lift the long sides of the cot upwards until they lock into position. Check that all four sides have engaged correctly by pressing down on each arm at the centres. If you have difficulty locking the sides, lift the centre of the base a little higher and start the process again.

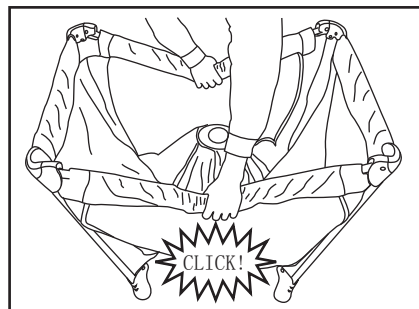

Step4

Now push the centre of the cot base downwards until it audibly locks into place.

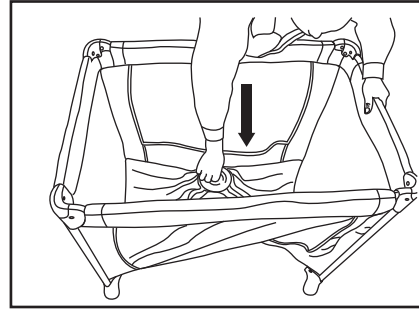

Step5

Place the mattress in the travel cot with the padded side up. Align the touch fasteners on the mattress with those on the base and press down to ensure they are stuck together.

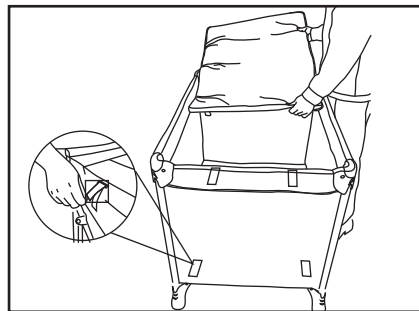

Note - The travel cot is ready for use, only when the locking mechanisms are engaged. Check carefully that they are fully engaged before using the travel cot

3. Folding

Step1

Lift the handle in the base under the mattress pull the centre of the base upwards.

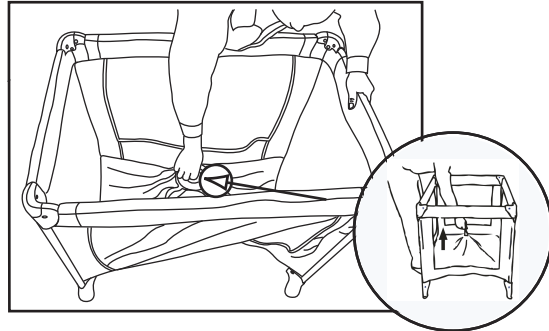

Step2

Lift the side rails slightly(a) and hold the lock in the middle of the rail (b) (indicated with arrows). Hold the lock pressed whilst gently lowering the side rail(c) . Ensure that the side rail disengages on both sides of the mechanism. Pull together the 2 supporting legs underneath the fabric to center base as close as possible (d).

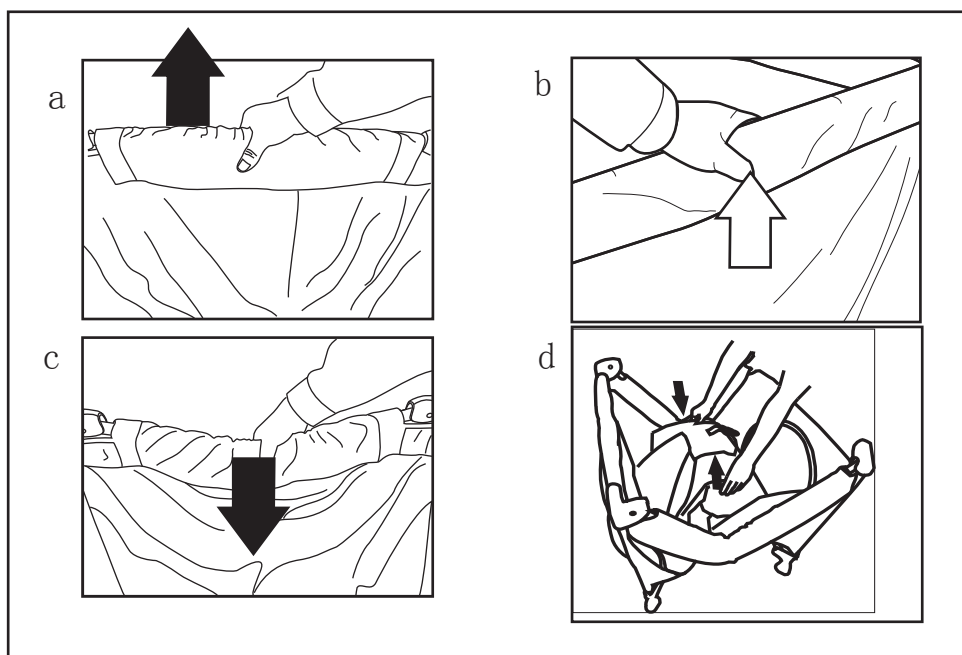
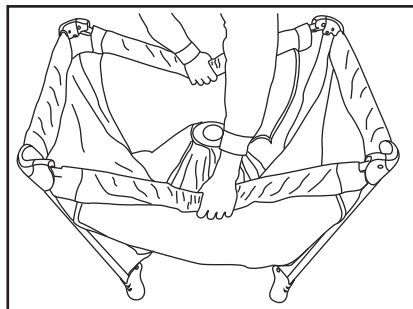

Step3

Repeat this process with the short sides. Check that all 4 sides have disengaged properly and then pull the centre of the base. If you have difficulty unlocking the sides, lift the centre of the base a little higher and start the process again.

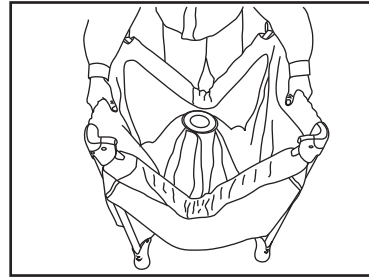

Step4

With the upper part of the travel cot in the closed position push all 4 feet together.

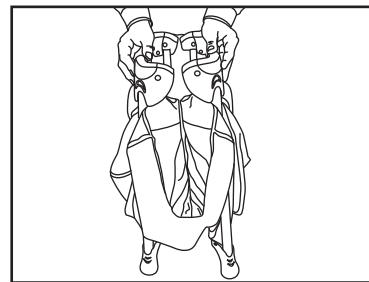

Step5

Wrap the mattress around the travel cot tightly with the padded section inside. Fasten the touch fasteners through the tabs and secure. Pull the travel bag over the travel cot and close the bag with the zip.

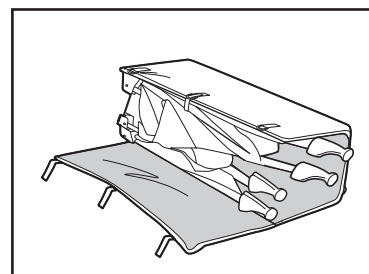

Care and Maintenance

Your child's safety is your responsibility

To clean the mattress base and travel cot fabric wipe it using a mild detergent and water. Never clean with abrasive, ammonia based, bleach based or spirit type cleaners. The travel cot must be dried thoroughly before use or storage.

Argos Limited

Avebury, 489-499 Avebury Boulevard, Milton Keynes, MK9 2NW

www.argos.co.uk

Customer Helpline: 03456 400 800